

CASA AUTO	MODELLO	PORTE	ANNO
VOLKSWAGEN	Polo VI (AW)	5	17>

M1	M2
6,00	4,5

G1	F1	G2	F2
06	B	05	A

T1	T2
28	X

Le tabelle di applicabilità sono soggette ad invecchiamento e/o modifiche, in caso di dubbio si consiglia di consultare il sito www.k39.it costantemente aggiornato.
The applicability tables are subject to aging and/or changes, in case of doubt it is advisable to consult the constantly updated website www.k39.it.



1



4 x

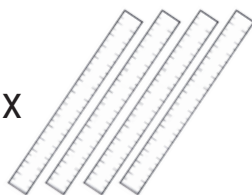

2 x M1

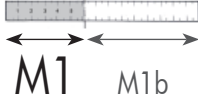

2 x M2

Tab. 1:
M1
M2

Tagliare i 4 metri in dotazione alla misura M1 ed M2 riportate in tabella

2

2 x



M1 - M2

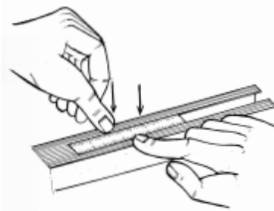
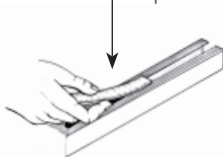

Inserire il metro tagliato in misura M1 nelle 2 cave della barra anteriore, portandolo fine a fine corsa.
Ripetere l'operazione per la barra posteriore con i metri tagliati in misura M2.

3

4 x

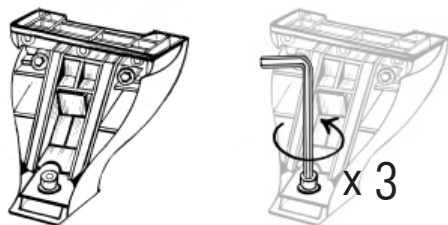

Prendere i 4 piedi dalla scatola, allentare la vite affinché i piedi possano entrare nella cava.

Prendere il primo piede ed inserirlo in cava facendo **ATTENZIONE** a non sormontare il metro precedentemente inserito, stringere con forza la vite del piede.

Ripetere l'operazione per tutti i 4 piedi ciascuno in una cava.

5 Nm

K1

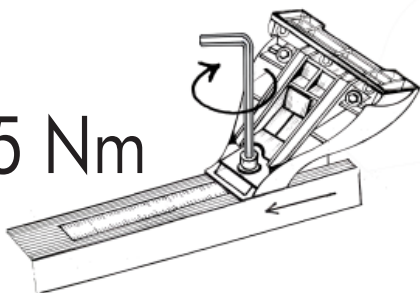

5 Nm

K1pro

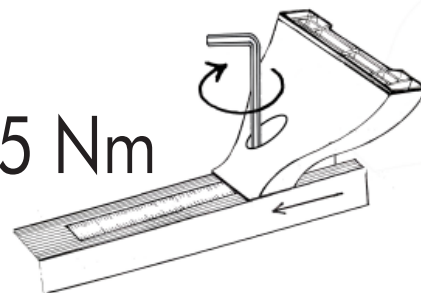

4

M1b - M2b



Inserire l'avanzo del metro tagliato (M1b per la barra anteriore ed M2b per la barra posteriore) per coprire la cava scoperta.

Ripetere l'operazione per tutte e 2 le barre.

Inserire, infine, i 4 tappi come indicato in figura.

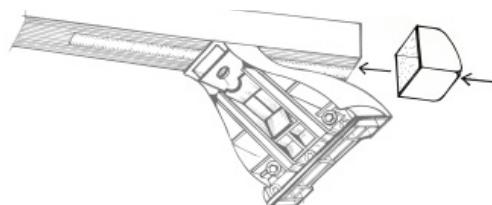
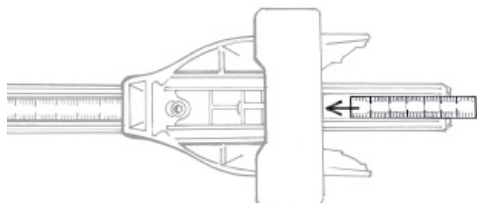

5



Tab. 1:
G1-F1
G2-F2

4 x

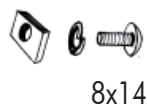
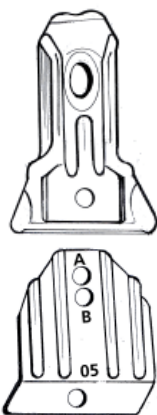

8x14

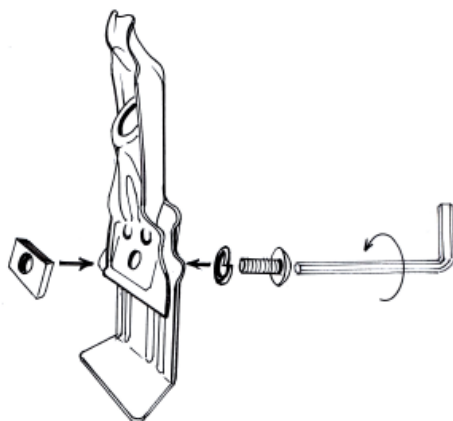

Assemblare le 4 GANASCINE come mostrato in figura, facendo **ATTENZIONE** a rispettare le misure riportate in tabella.

Lasciare la parte inferiore della ganascina lasca.

6

8x50

4 x

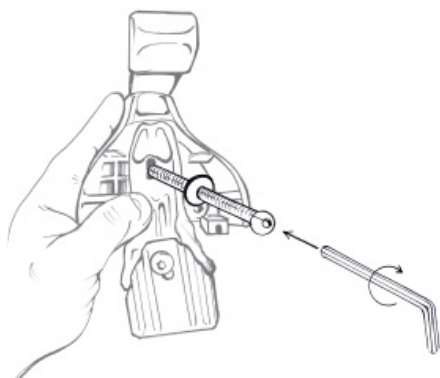

Posizionare la barra anteriore e la barra posteriore sul tetto dell'autovettura. Fissare le ganascine ai 4 piedi facendo **ATTENZIONE** a non stringere completamente la vite.

7

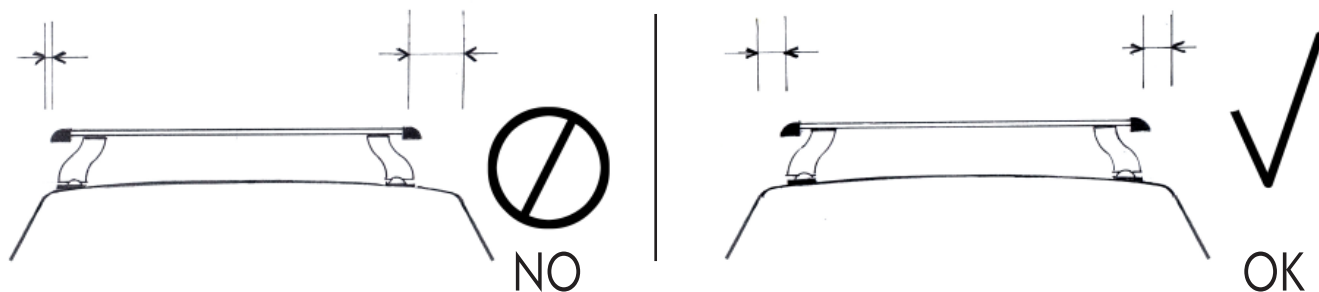

8a

2 x
6x12

CASA AUTO	MODELLO	PORTE	ANNO
VOLKSWAGEN	Polo VI (AW)	5	17→

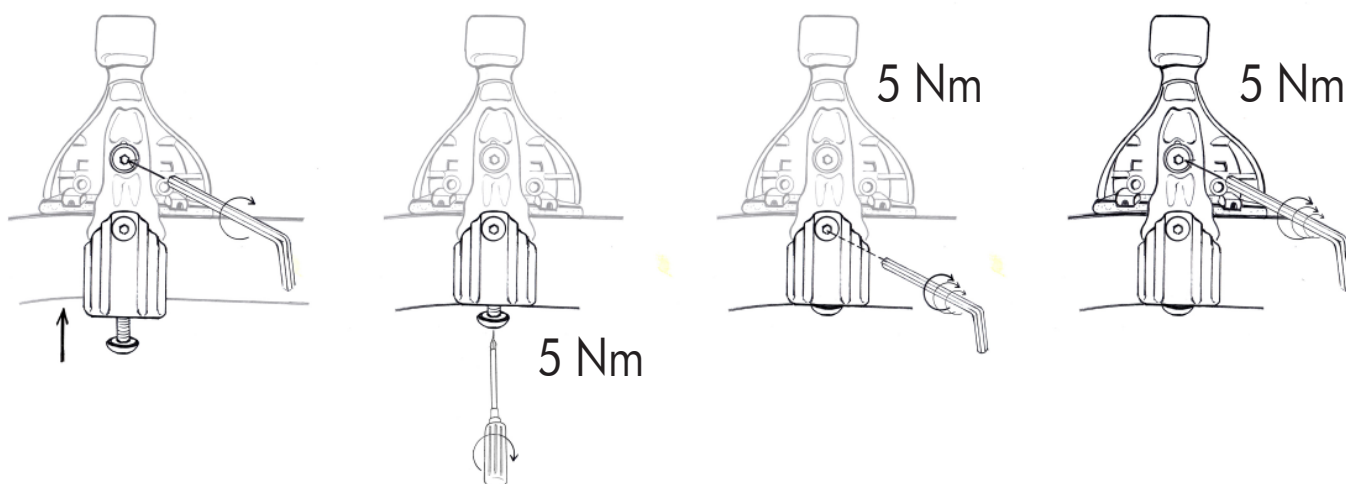
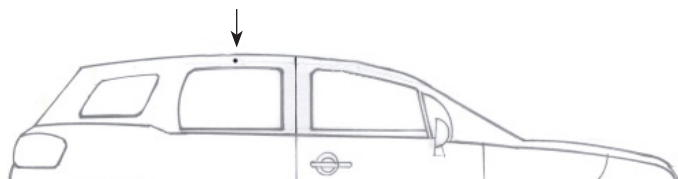

Stringere la vite superiore fino ad accompagnare la parte inferiore della ganascina al tetto. Stringere la vite inferiore arrivando a fine corsa. Stringere con forza la vite di congiunzione della ganascia. Stringere con forza la vite superiore facendo **ATTENZIONE** a non spostare la centratura delle barre. Per ottenere il risultato corretto stringere le viti alternando il lato destro al lato sinistro in maniera uniforme.

8b

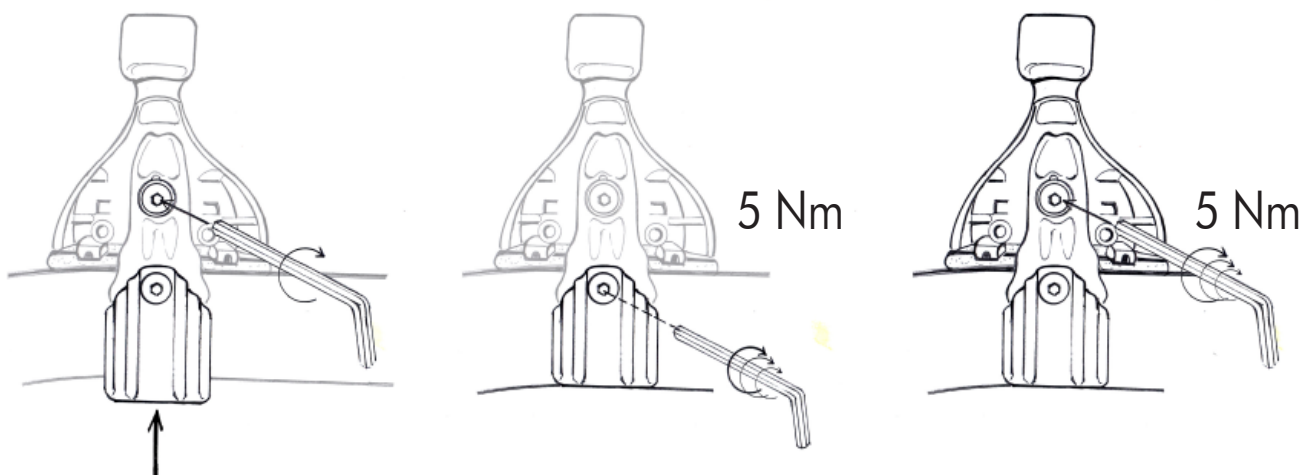
Tab. 1:
T2

Stringere la vite superiore fino ad accompagnare la parte inferiore della ganascina al tetto. Stringere con forza la vite inferiore. Stringere con forza la vite superiore facendo **ATTENZIONE** a non spostare la centratura delle barre. Per ottenere il risultato corretto stringere le viti alternando il lato destro al lato sinistro in maniera uniforme.

9a



K1



9b



K1pro

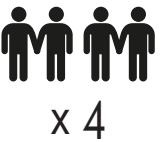

MAX
55 kg



NO

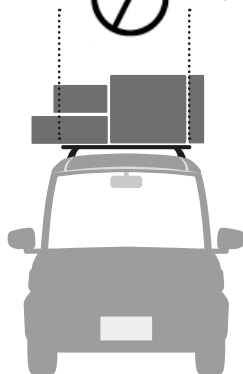

OK

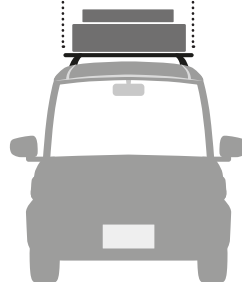

NO

