

CASA AUTO	MODELLO	PORTE	ANNO
PEUGEOT	206	3	98>09
PEUGEOT	206 Plus	3	09>12

M1	M2
6,8	9,0
6,8	9,0

G1	F1	G2	F2
18	1 foro A	12	1 foro A
18	1 foro A	12	1 foro A

T1	T2
X	X
X	X

Le tabelle di applicabilità sono soggette ad invecchiamento e/o modifiche, in caso di dubbio si consiglia di consultare il sito [www.k39.it](http://www.k39.it) costantemente aggiornato.  
The applicability tables are subject to aging and/or changes, in case of doubt it is advisable to consult the constantly updated website [www.k39.it](http://www.k39.it).



1



4 x

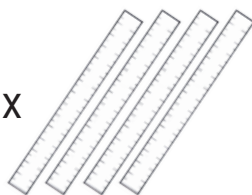

2 x M1

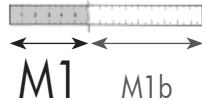

2 x M2

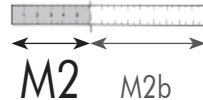

Tagliare i 4 metri in dotazione alla misura M1 ed M2 riportate in tabella

Tab. 1:  
M1  
M2

2

2 x

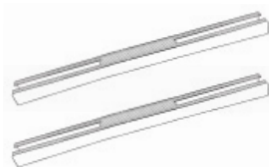

M1 - M2

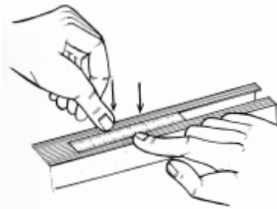
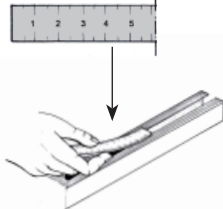

Inserire il metro tagliato in misura M1 nelle 2 cave della barra anteriore, portandolo fine a fine corsa.  
Ripetere l'operazione per la barra posteriore con i metri tagliati in misura M2.

3

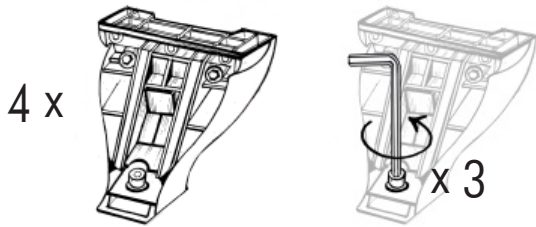

Prendere i 4 piedi dalla scatola, allentare la vite affinché i piedi possano entrare nella cava.

Prendere il primo piede ed inserirlo in cava facendo **ATTENZIONE** a non sormontare il metro precedentemente inserito, stringere con forza la vite del piede.

Ripetere l'operazione per tutti i 4 piedi ciascuno in una cava.

5 Nm

K1

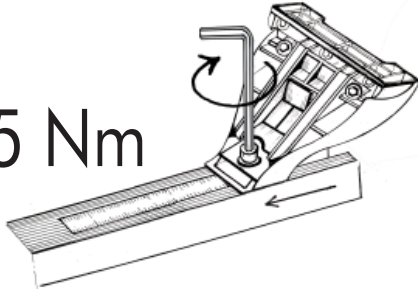

5 Nm

K1pro

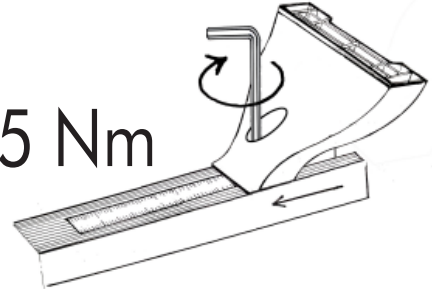

4

M1b - M2b



Inserire l'avanzo del metro tagliato (M1b per la barra anteriore ed M2b per la barra posteriore) per coprire la cava scoperta.

Ripetere l'operazione per tutte e 2 le barre.

Inserire, infine, i 4 tappi come indicato in figura.

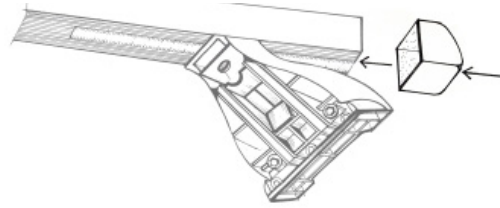
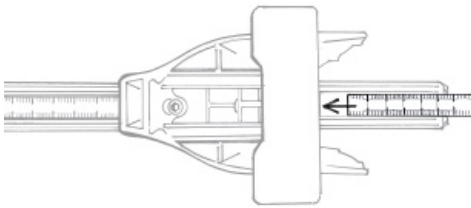

5



Tab. 1:  
G1-F1  
G2-F2

4 x

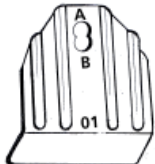

8x14

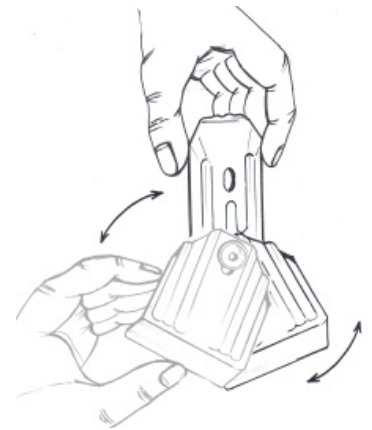
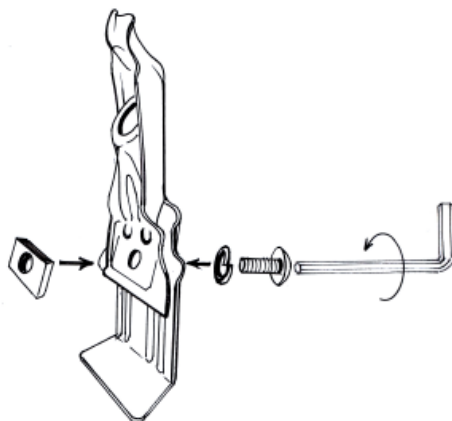

Assemblare le 4 GANASCINE come mostrato in figura, facendo **ATTENZIONE** a rispettare le misure riportate in tabella.

Lasciare la parte inferiore della ganascina lasca.

6

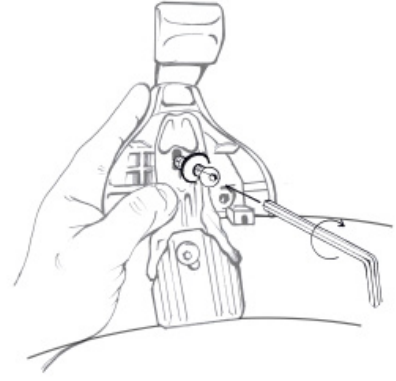
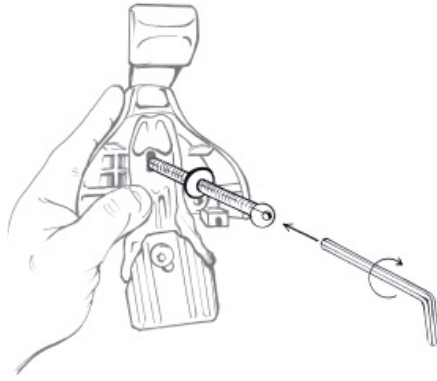

Posizionare la barra anteriore e la barra posteriore sul tetto dell'autovettura. Fissare le ganascine ai 4 piedi facendo **ATTENZIONE** a non stringere completamente la vite.

7

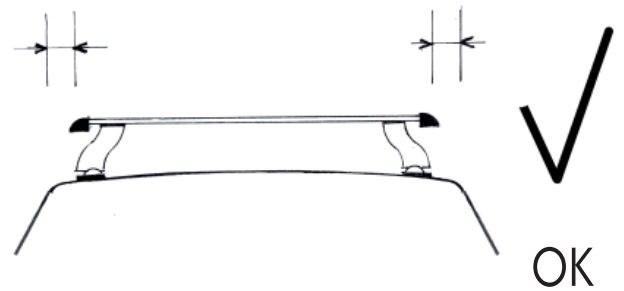
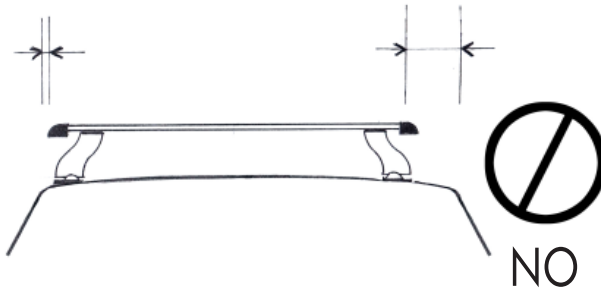

8

2 x  
6x18



CASA AUTO	MODELLO	PORTE	ANNO
PEUGEOT	206	3	98→09
PEUGEOT	206 Plus	3	09→12

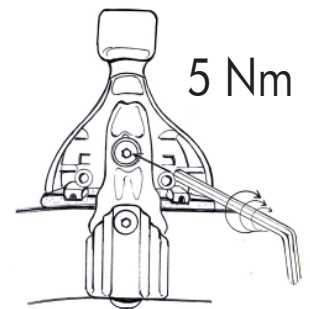
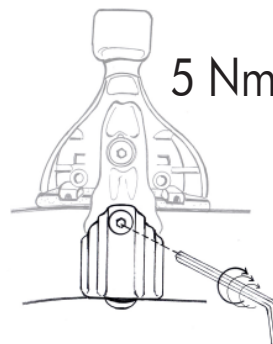
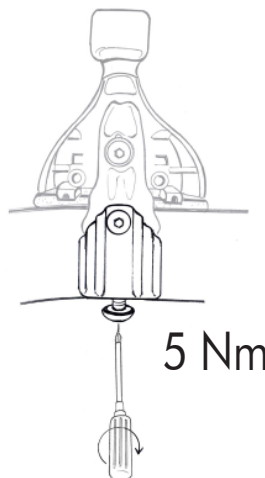
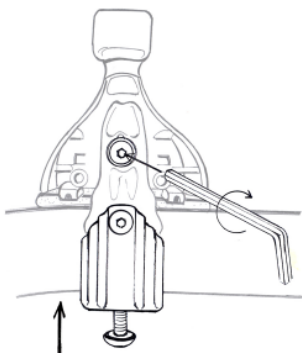
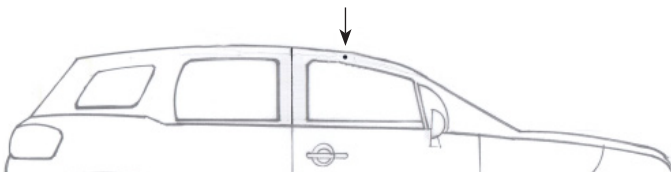

Stringere la vite superiore fino ad accompagnare la parte inferiore della ganascina al tetto. Stringere la vite inferiore arrivando a fine corsa. Stringere con forza la vite di congiunzione della ganascina. Stringere con forza la vite superiore facendo **ATTENZIONE** a non spostare la centratura delle barre. Per ottenere il risultato corretto stringere le viti alternando il lato destro al lato sinistro in maniera uniforme.

9a



K1



x 4

9b



K1pro



x 4

MAX  
55 kg

