

CASA AUTO	MODELLO	PORTE	ANNO
VOLKSWAGEN	Golf VIII	5	19 >

M1	M2
7	4,8

G1	F1	G2	F2
44	1 foro A	01	B

T1	T2
X	36

Le tabelle di applicabilità sono soggette ad invecchiamento e/o modifiche, in caso di dubbio si consiglia di consultare il sito www.k39.it costantemente aggiornato.
The applicability tables are subject to aging and/or changes, in case of doubt it is advisable to consult the constantly updated website www.k39.it.

1



4 x



2 x M1



M1 M1b

2 x M2



M2 M2b

Tagliare i 4 metri in dotazione alla misura M1 ed M2 riportate in tabella

2

2 x



M1 - M2

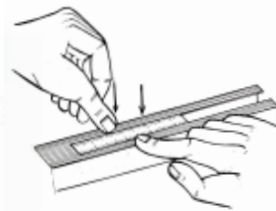
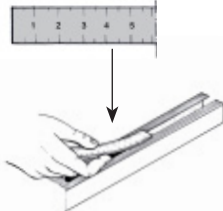

Inserire il metro tagliato in misura M1 nelle 2 cave della barra anteriore, portandolo fine a fine corsa.
Ripetere l'operazione per la barra posteriore con i metri tagliati in misura M2.

3

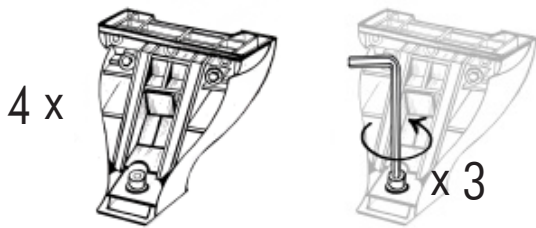

Prendere i 4 piedi dalla scatola, allentare la vite affinché i piedi possano entrare nella cava.
Prendere il primo piede ed inserirlo in cava facendo **ATTENZIONE** a non sormontare il metro precedentemente inserito, stringere con forza la vite del piede.
Ripetere l'operazione per tutti i 4 piedi ciascuno in una cava.

5 Nm

K1

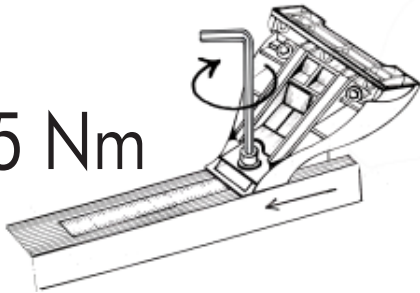

5 Nm

K1pro

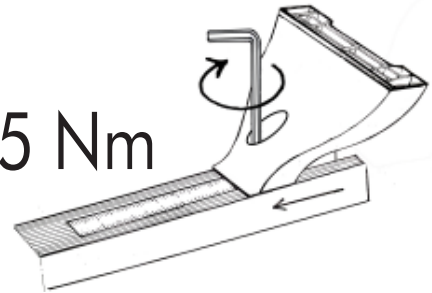

4



Inserire l'avanzo del metro tagliato (M1b per la barra anteriore ed M2b per la barra posteriore) per coprire la cava scoperta.
Ripetere l'operazione per tutte e 2 le barre.
Inserire, infine, i 4 tappi come indicato in figura.

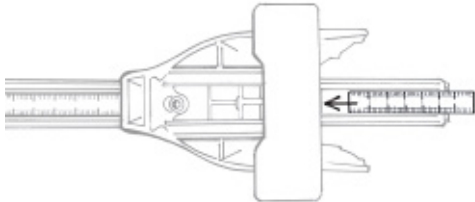

5



Tab. 1:
G1-F1
G2-F2

4 x

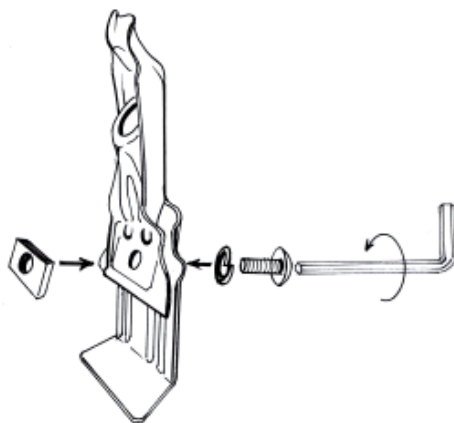
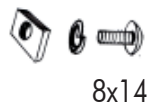
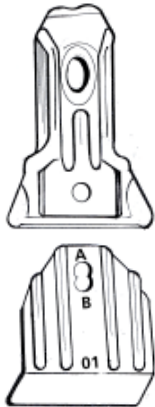

Assemblare le 4 GANASCINE come mostrato in figura, facendo **ATTENZIONE** a rispettare le misure riportate in tabella.
Lasciare la parte inferiore della ganascina lasca.

6

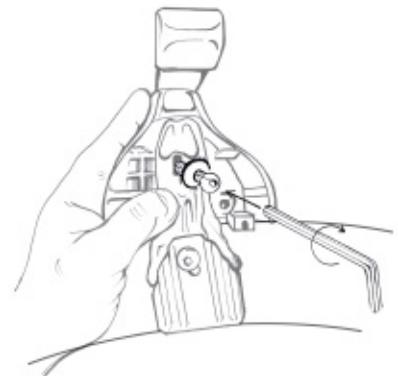
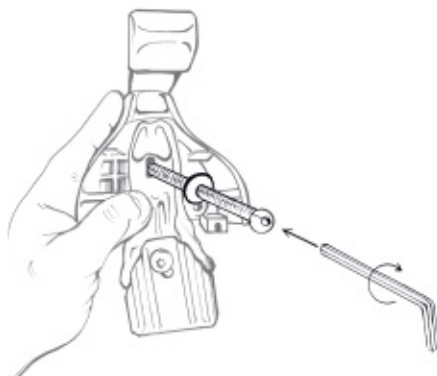

Posizionare la barra anteriore e la barra posteriore sul tetto dell'autovettura. Fissare le ganascine ai 4 piedi facendo **ATTENZIONE** a non stringere completamente la vite.

7

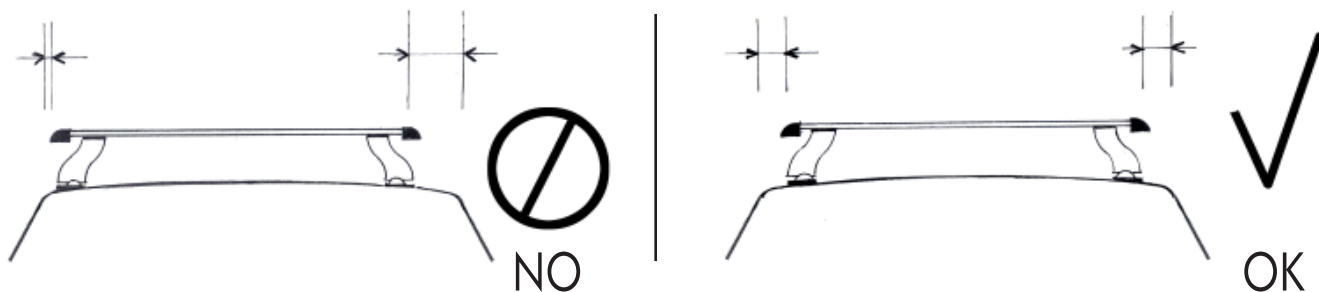

8a

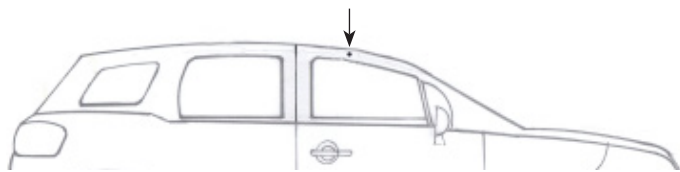
Tab. 1:
T1

ATTENZIONE: utilizzare i fori interni della predisposizione originale, dopo aver rimosso i tappi in plastica.

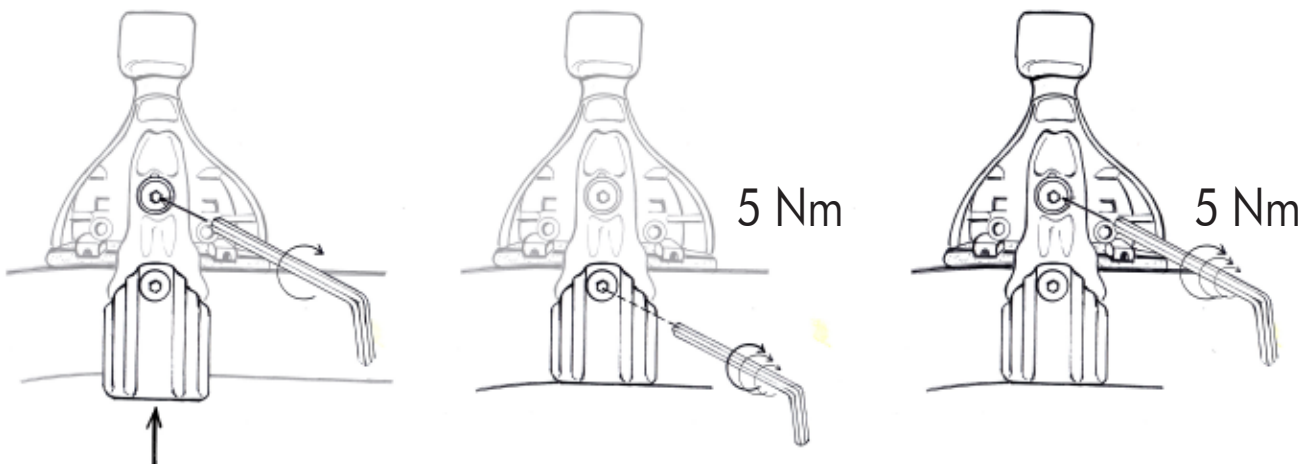

Stringere la vite superiore fino ad accompagnare la parte inferiore della ganascina al tetto. Stringere con forza la vite inferiore. Stringere con forza la vite superiore facendo **ATTENZIONE** a non spostare la centratura delle barre. Per ottenere il risultato corretto stringere le viti alternando il lato destro al lato sinistro in maniera uniforme.

8b

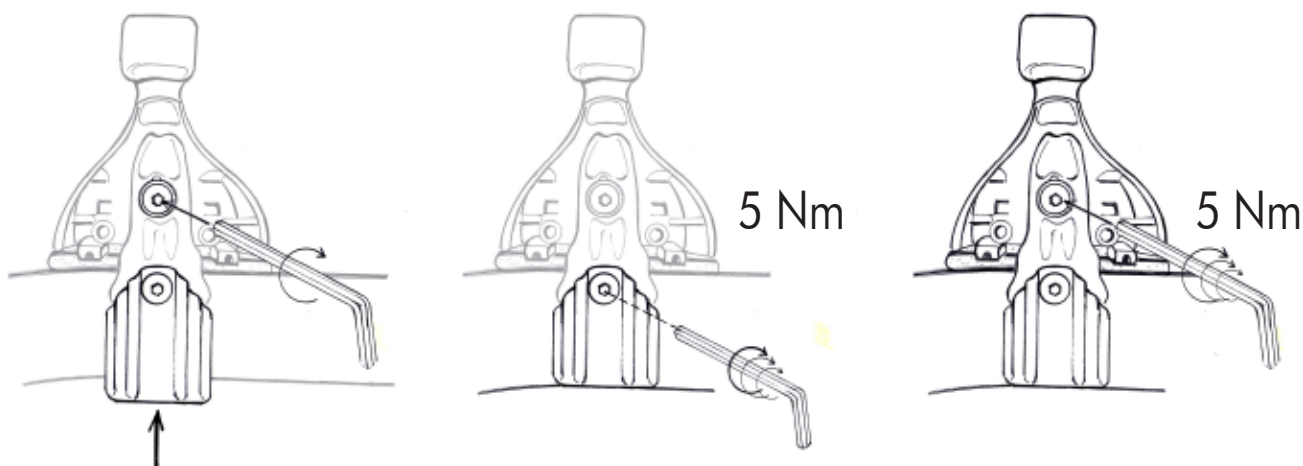
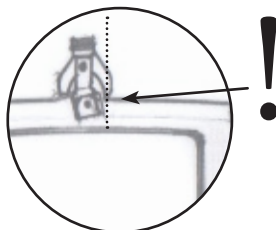
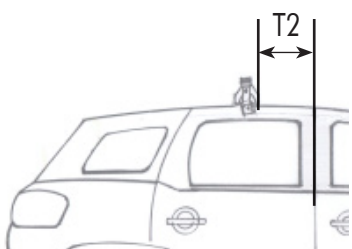
Tab. 1:
T2

Stringere la vite superiore fino ad accompagnare la parte inferiore della ganascina al tetto. Stringere con forza la vite inferiore. Stringere con forza la vite superiore facendo **ATTENZIONE** a non spostare la centratura delle barre. Per ottenere il risultato corretto stringere le viti alternando il lato destro al lato sinistro in maniera uniforme.

9a



K1



x 4

9b



K1pro



x 4

MAX
55 kg



NO

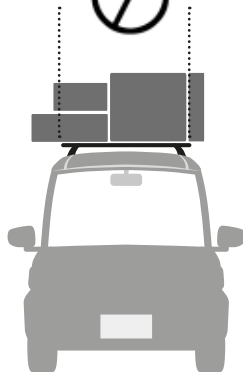

OK

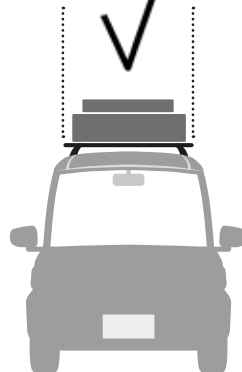

NO

